

# 1 Select Your Mount Type:

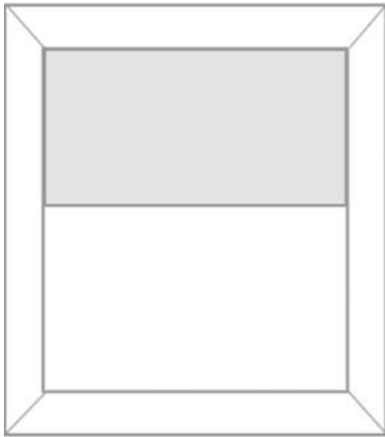

## Inside Mount:

Inside Mount Roman Shades are mounted within the Frame of the window and secured to top window sash. An Inside Mount Shade will require a minimum of 2-1/2" of depth within the window casing (See Step 3).

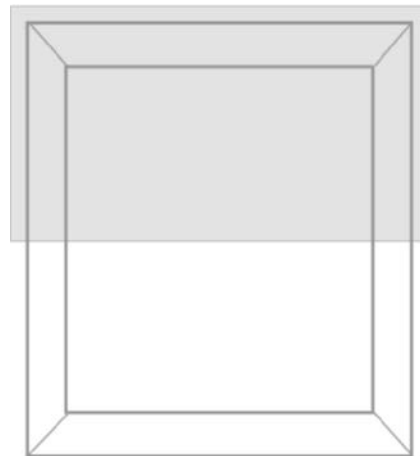

## Outside Mount:

Outside Mount Roman Shades are mounted on the molding or wall surrounding the window. Outside Mount Shades are a good option when there is not enough available depth within the window casing to mount the shade.

2 Measure Your Windows:

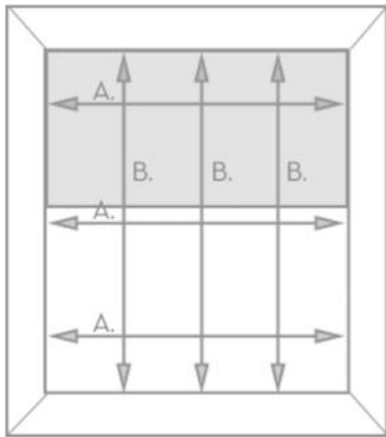

Inside Mount:

A. Measure the Inside Width at three locations: the top, middle and bottom. Take the smallest of the three - this is your ordering width. DrapeStyle will take a deduction of  $\frac{3}{8}$ " -  $\frac{1}{2}$ " for mounting.

B. Measure the Height at three locations: left, middle and right. Take the largest of the three - this is your ordering length.

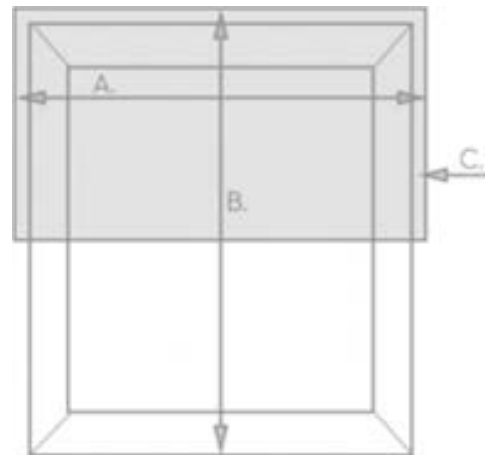

Outside Mount:

A. Measure the total width of your coverage area. We recommend adding 1" - 1-1/2" to each side beyond the casing of your Window (C). This is your ordering width.

B. Measure the height of the coverage area. Add a minimum of 1" above top casing for mounting.

### 3 Casing Depth (Inside Mount Only):

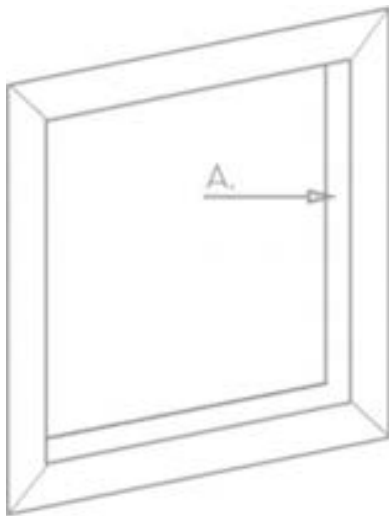

#### Inside Mount:

A. When ordering an Inside Mount please be sure you have at least 2-1/2" of depth within your window frame.

4 Select Your Cord Position:

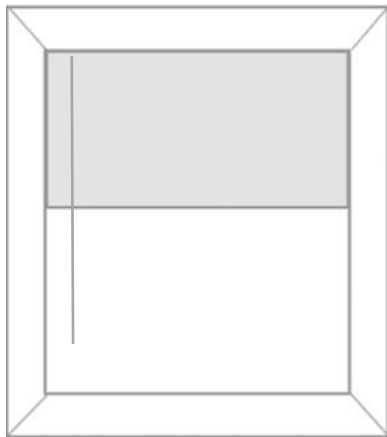

Left Cord Position:

Cord will be strung on left of shade.

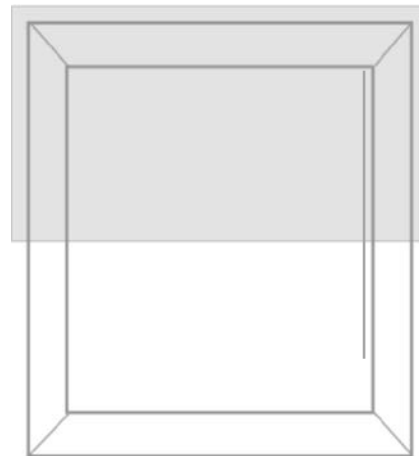

Right Cord Position:

Cord will be strung on right of shade.

## 5 Cord Type

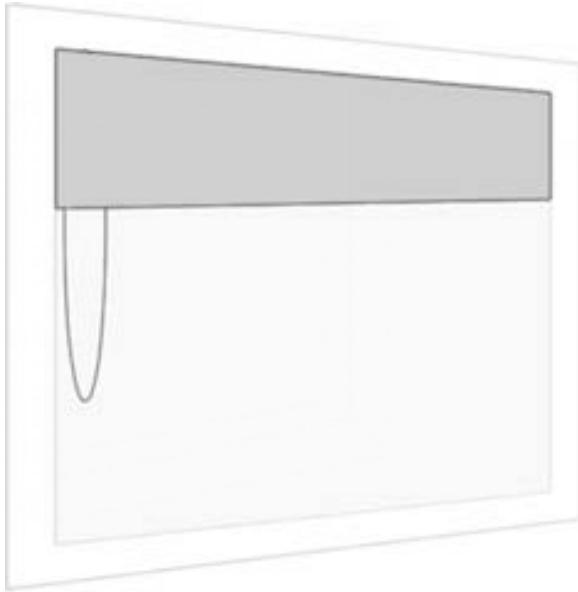

### Continuous Cord:

- > Continuous Silver Bead Chain
- > Simple Operation
- > No Need for Cord Cleat